

SHURE BROTHERS



Microphone Headquarters

225 WEST HURON STREET • CHICAGO • U.S.A
TELEPHONE DELAWARE 8383 • CABLE: SHUREMICRO

SPECIFICATION SHEET

NO: 102

DATE: October 1941

SUBJECT: Models 91-01, 91-02 and 91-05
Military-type Carbon Microphones

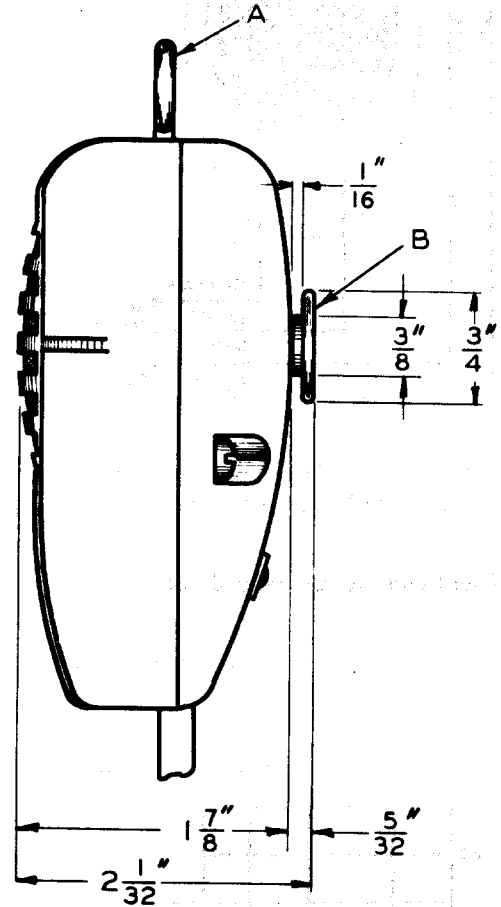
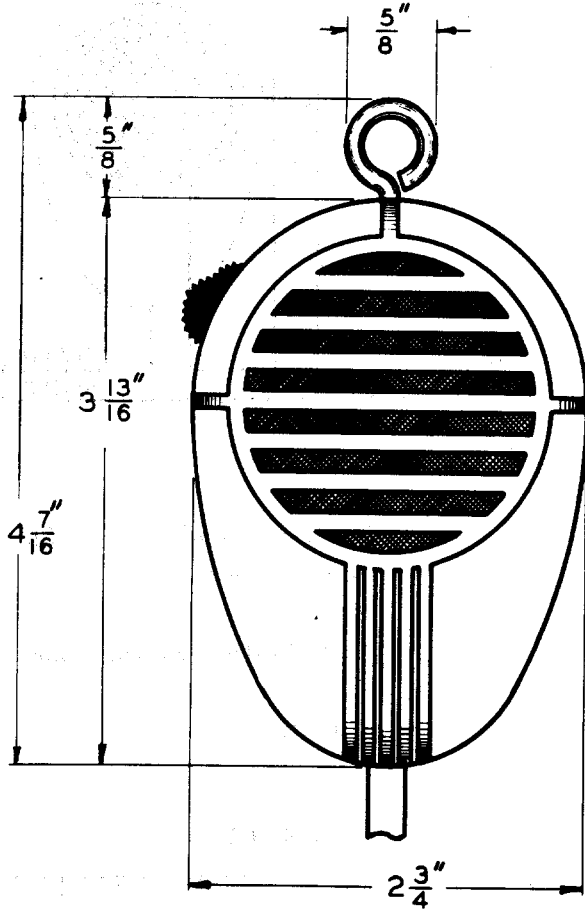

**MOUNTING
BRACKET
ASSEMBLY
99-160**

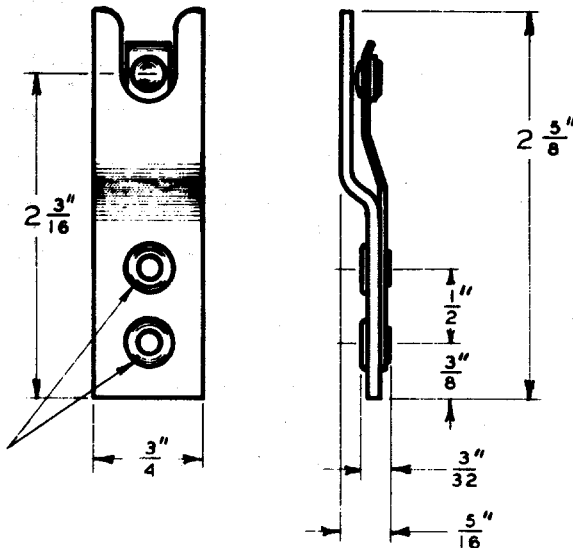

Mounting Holes
Clearance for
No. 6 Screw

**NOTE: HANGER "A" AND
MOUNTING STUD "B"
OPTIONAL.**

**FOR MOUNTING BRACKET
SPECIFY ASSEMBLY 99-160.**

STANDARD SWITCH and CABLE ASSEMBLIES

MODEL 91-01

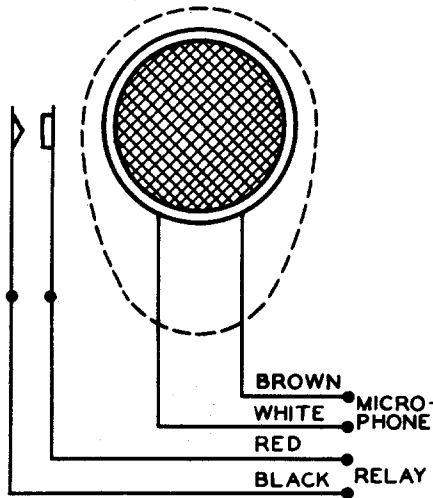

No Microphone Switch.
Relay Switch Normally Open.

Four Conductor Unshielded Cable.

MODEL 91-02

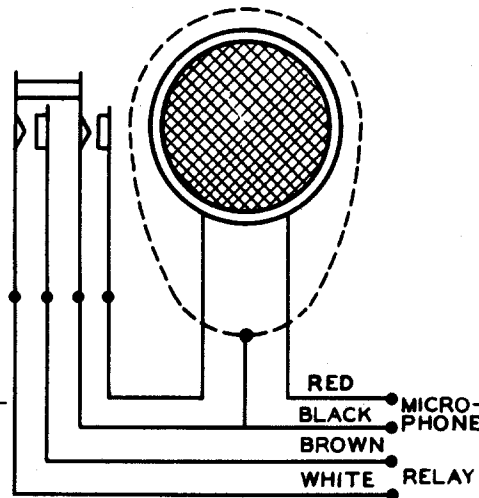

Microphone Switch Normally Open.
Relay Switch Normally Open.

Four Conductor Unshielded Cable.

MODEL 91-05

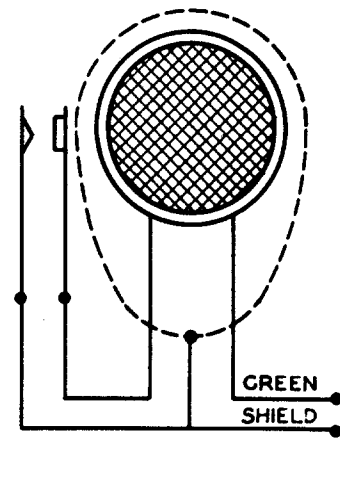

Microphone Switch Normally Open.
No Relay Switch.

Single Conductor Shielded Cable.

Other Switch and Cable Combinations Available on Special Order

TYPICAL FREQUENCY RESPONSE MODELS 91-01, 91-02, 91-05

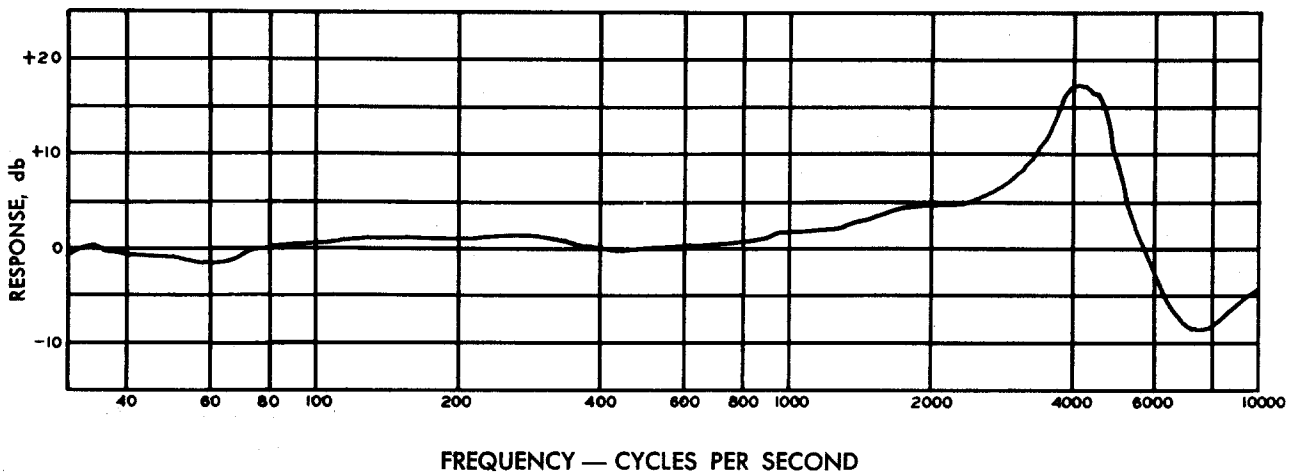

0 db=43 db Below One Volt Per Dyne Per Square Centimeter
Recommended Operating Voltage — 2 to 3 Volts
Recommended Operating Current — 10 to 15 Milliamperes
Microphone Resistance — 200 Ohms